 Valvola a sfera 2 vie in ottone, passaggio totale secondo norma DIN 13547 [RB art. 2500] filettatura F/F non idonea per solventi.

 2 way, brass ball valve, full bore according to DIN 13547 [RB art. 2500] threaded F/F, not suitable for use with solvents.



Art. 8P007900

Con attuatore pneumatico doppio effetto serie 82.
 With double acting pneumatic actuator series 82.

MISURA-SIZE	1/4"	3/8"	1/2"	3/4"	1"	1"1/4	1"1/2	2"	2"1/2	3"	4"
PN	40	40	40	40	40	40	40	40	25	16	16
ACT.	DA32	DA32	DA32	DA32	DA32	DA32	DA52	DA52	DA63	DA63	DA85
KIT	RI4015	RI4015	RI4015	RI4015	RI4015	RI4015	RI4016	RI4016	RI4021	RI4021	RI4021

Art. 8P008100

Con attuatore pneumatico semplice effetto serie 82.
 With spring return pneumatic actuator series 82.

MISURA-SIZE	1/4"	3/8"	1/2"	3/4"	1"	1"1/4	1"1/2	2"	2"1/2	3"	4"
PN	40	40	40	40	40	40	40	40	25	16	16
ACT.	SR52	SR52	SR52	SR52	SR52	SR52	SR63	SR63	SR85	SR85	SR100
KIT	RI4017	RI4017	RI4017	RI4017	RI4017	RI4017	RI4018	RI4018	RI4020	RI4020	RI4029



Art. 8E014***



Con attuatore elettrico serie 85.
 With electric actuator series 85.

MISURA-SIZE	1/4"	3/8"	1/2"	3/4"	1"	1"1/4	1"1/2	2"	2"1/2	3"	4"
PN	40	40	40	40	40	40	40	40	25	16	16
ACT.	VB015	VB015	VB015	VB015	VB015	VB015	VB030	VB030	VB060	VB060	VB110
KIT	RI4017	RI4017	RI4017	RI4017	RI4017	RI4017	RI4016	RI4016	RI4021	RI4021	RI4021

12 V
 24 V
 100 - 240 V

*** CODICE TENSIONE - VOLTAGE CODE		
12V AC/DC + 001	24V AC/DC + 002	100-240V AC + 004



-  Valvola a sfera 2 vie in ottone [RB art. 2530] filettatura F/F asta e sfera in inox, passaggio totale, secondo norma DIN 13547 certificata ATEX Ex II 2 G/D c T4 idonea per impieghi con solventi.
-  2 way, brass ball valve [RB art. 2530] threaded F/F, stainless steel stem and ball, full bore, according to DIN 13547 certified ATEX Ex II 2 G/D c T4, suitable for use with solvents.



Art. 8P015900 Con attuatore pneumatico doppio effetto serie 82.
With double acting pneumatic actuator series 82.

MISURA-SIZE	1/4"	3/8"	1/2"	3/4"	1"	1"1/4	1"1/2	2"
PN	40	40	40	40	40	40	40	40
ACT.	DA32	DA32	DA32	DA32	DA32	DA32	DA52	DA52
KIT	RI4015	RI4015	RI4015	RI4015	RI4015	RI4015	RI4016	RI4016

Art. 8P016000 Con attuatore pneumatico semplice effetto serie 82.
With spring return pneumatic actuator series 82.

MISURA-SIZE	1/4"	3/8"	1/2"	3/4"	1"	1"1/4	1"1/2	2"
PN	40	40	40	40	40	40	40	40
ACT.	SR52	SR52	SR52	SR52	SR52	SR52	SR63	SR63
KIT	RI4017	RI4017	RI4017	RI4017	RI4017	RI4017	RI4018	RI4018



Art. 8E046*** Con attuatore elettrico serie 85.
With electric actuator series 85.

MISURA-SIZE	1/4"	3/8"	1/2"	3/4"	1"	1"1/4	1"1/2	2"
PN	40	40	40	40	40	40	40	40
ACT.	VB015	VB015	VB015	VB015	VB015	VB015	VB030	VB030
KIT	RI4017	RI4017	RI4017	RI4017	RI4017	RI4017	RI4016	RI4016
12 V								
24 V								
100 - 240 V								

*** CODICE TENSIONE - VOLTAGE CODE		
12V AC/DC + 001	24V AC/DC + 002	100-240V AC + 004



 Valvola a sfera 2 vie [Valpres art. 700000] in acciaio inox AISI 316-CF8M, filettatura F/F.

 2 way ball valve [Valpres art. 700000] stainless steel AISI 316-CF8M, threaded F/F.



Art. 8P000100 Con attuatore pneumatico doppio effetto serie 82.
 With double acting pneumatic actuator series 82.

MISURA-SIZE	1/4"	3/8"	1/2"	3/4"	1"	1"1/4"	1"1/2"	2"	2"1/2"	3"	4"
PN	140	140	140	105	105	64	64	64	25	25	25
ACT.	DA32	DA32	DA32	DA52	DA52	DA52	DA63	DA75	DA85	DA85	DA100
KIT	RI3784	RI3784	RI3784	RI3781	RI3030	RI3030	RI3031	RI3034	RI3003	RI3003	RI3004

Art. 8P000200 Con attuatore pneumatico semplice effetto serie 82.
 With spring return pneumatic actuator series 82.

MISURA-SIZE	1/4"	3/8"	1/2"	3/4"	1"	1"1/4"	1"1/2"	2"	2"1/2"	3"	4"
PN	140	140	140	105	105	64	64	64	25	25	25
ACT.	SR52	SR52	SR52	SR63	SR63	SR63	SR85	SR100	SR115	SR125	SR125
KIT	RI3782	RI3782	RI3782	RI3783	RI3033	RI3033	RI3034	RI3034	RI3010	RI3010	RI3005



Art. 8E000*** Con attuatore elettrico serie 85.
 With electric actuator series 85.

MISURA-SIZE	1/4"	3/8"	1/2"	3/4"	1"	1"1/4"	1"1/2"	2"	2"1/2"	3"	4"
PN	140	140	140	105	105	64	64	64	25	25	25
ACT.	VB015	VB015	VB015	VB015	VB030	VB030	VB060	VB060	VB110	VB110	VB190
KIT	RI3782	RI3782	RI3782	RI3781	RI3030	RI3030	RI3031	RI3031	RI3003	RI3003	RI3004

12 V
 24 V
 100 - 240 V

*** CODICE TENSIONE - VOLTAGE CODE		
12V AC/DC + 001	24V AC/DC + 002	100-240V AC + 004



 Valvola a sfera 2 vie [Valpres art. 705000] acciaio al carbonio ASTM A105-WCB con sfera ed asta in acciaio inox AISI 304, filettatura F/F a passaggio totale.

 2 way ball valve [Valpres art. 705000] carbon steel ASTM A105-WCB, with ball and stem in stainless steel AISI 304, threaded F/F, full bore.



Art. 8P039700 Con attuatore pneumatico doppio effetto serie 82.
With double acting pneumatic actuator series 82.

MISURA-SIZE	1/4"	3/8"	1/2"	3/4"	1"	1"1/4	1"1/2	2"
PN	64	64	64	64	64	64	64	64
ACT.	DA32	DA32	DA32	DA52	DA52	DA52	DA63	DA75
KIT	RI3784	RI3784	RI3784	RI3781	RI3030	RI3030	RI3031	RI3034

Art. 8P039800 Con attuatore pneumatico semplice effetto serie 82.
With spring return pneumatic actuator series 82.

MISURA-SIZE	1/4"	3/8"	1/2"	3/4"	1"	1"1/4	1"1/2	2"
PN	64	64	64	64	64	64	64	64
ACT.	SR52	SR52	SR52	SR63	SR63	SR63	SR85	SR100
KIT	RI3782	RI3782	RI3782	RI3783	RI3033	RI3033	RI3034	RI3034





Art. 8E178*** Con attuatore elettrico serie 85.
With electric actuator series 85.

MISURA-SIZE	1/4"	3/8"	1/2"	3/4"	1"	1"1/4	1"1/2	2"
PN	64	64	64	64	64	64	64	64
ACT.	VB015	VB015	VB015	VB015	VB030	VB030	VB060	VB060
KIT	RI3782	RI3782	RI3782	RI3781	RI3030	RI3030	RI3031	RI3031
12 V								
24 V								
100 - 240 V								

*** CODICE TENSIONE - VOLTAGE CODE		
12V AC/DC + 001	24V AC/DC + 002	100-240V AC + 004



 Valvola a sfera 2 vie [Valpres art. 703000] in acciaio inox AISI 316-CF8M, filettatura F/F, asta antistatica, non idonea per impieghi con solventi.

 2 way ball valve [Valpres art. 703000] stainless steel AISI 316-CF8M, threaded F/F, Antistatic Device, not suitable for use with solvents.



Art. 8P000300 Con attuatore pneumatico doppio effetto serie 82.
 With double acting pneumatic actuator series 82.

MISURA-SIZE	1/2"	3/4"	1"	1"1/4	1"1/2	2"	3"
PN	64	64	64	64	64	64	25
ACT.	DA32	DA32	DA32	DA32	DA52	DA52	DA75
KIT	RI4015	RI4015	RI4015	RI4015	RI4016	RI4016	RI5031

Art. 8P000400 Con attuatore pneumatico semplice effetto serie 82.
 With spring return pneumatic actuator series 82.

MISURA-SIZE	1/2"	3/4"	1"	1"1/4	1"1/2	2"	3"
PN	64	64	64	64	64	64	25
ACT.	SR52	SR52	SR52	SR52	SR63	SR63	SR100
KIT	RI4017	RI4017	RI4017	RI4017	RI4018	RI4018	RI5031



Art. 8E003*** Con attuatore elettrico serie 85.
 With electric actuator series 85.

MISURA-SIZE	1/2"	3/4"	1"	1"1/4	1"1/2	2"	3"
PN	64	64	64	64	64	64	25
ACT.	VB015	VB015	VB015	VB015	VB030	VB030	VB060*
KIT	RI4017	RI4017	RI4017	RI4017	RI4016	RI4016	RI5031
12 V							
24 V							
100 - 240 V							

*Versione speciale - Special version.

***	CODICE TENSIONE - VOLTAGE CODE	
12V AC/DC + 001	24V AC/DC + 002	100-240V AC + 004



Valvola a sfera 2 vie in tre pezzi, passaggio totale [Valpres artt. 710000 F/F - 711000 SW - 712000 BW] acciaio inox AISI 316.

2 way, three piece ball valve, full bore [Valpres artt. 710000 F/F - 711000 SW - 712000 BW] stainless steel AISI 316.



Art. 8P000700 F/F Con attuatore pneumatico doppio effetto serie 82.
Art. 8P000800 SW With double acting pneumatic actuator series 82.
Art. 8P000900 BW

MISURA-SIZE	1/4**	3/8"	1/2"	3/4"	1"	1"1/4	1"1/2	2"	2"1/2	3"	4"
PN	64	64	64	40	40	25	25	25	16	16	16
ACT.	DA32	DA32	DA32	DA52	DA52	DA52	DA63	DA75	DA85	DA85	DA100
KIT	RI3015	RI3015	RI3789	RI3781	RI3030	RI3030	RI3031	RI3034	RI3003	RI3003	RI3004

*Solo F/F - Only F/F.

Art. 8P001300 F/F Con attuatore pneumatico semplice effetto serie 82.
Art. 8P001400 SW With spring return pneumatic actuator series 82.
Art. 8P001500 BW

MISURA-SIZE	1/4**	3/8"	1/2"	3/4"	1"	1"1/4	1"1/2	2"	2"1/2	3"	4"
PN	64	64	64	40	40	25	25	25	16	16	16
ACT.	SR52	SR52	SR52	SR63	SR63	SR63	SR85	SR100	SR115	SR125	SR125
KIT	RI3021	RI3021	RI3790	RI3783	RI3033	RI3033	RI3034	RI3034	RI3010	RI3010	RI3005

*Solo F/F - Only F/F.



Art. 8E002* F/F** Con attuatore elettrico serie 85.
Art. 8E030* SW** With electric actuator series 85.
Art. 8E031* BW**

MISURA-SIZE	1/4**	3/8"	1/2"	3/4"	1"	1"1/4	1"1/2	2"	2"1/2	3"	4"
PN	64	64	64	40	40	25	25	25	16	16	16
ACT.	VB015	VB015	VB015	VB015	VB030	VB030	VB060	VB060	VB110	VB110	VB190
KIT	RI3021	RI3021	RI3790	RI3781	RI3030	RI3030	RI3031	RI3031	RI3003	RI3003	RI3004

12 V
24 V
100 - 240 V

*Solo F/F - Only F/F.



Art. 8M002* F/F** Con attuatore elettrico serie 86.
Art. 8M030* SW** With electric actuator series 86.
Art. 8M031* BW**

MISURA-SIZE	1/4"	3/8"	1/2"	3/4"	1"	1"1/4	1"1/2	2"	2"1/2	3"	4"
PN	-	-	-	-	40	25	25	25	16	16	16
ACT.	-	-	-	-	VB030M	VB030M	VB060M	VB060M	VB110M	VB110M	VB190M
KIT	-	-	-	-	RI3030	RI3030	RI3031	RI3031	RI3003	RI3003	RI3004

12 V
24 V
100 - 240 V

*** CODICE TENSIONE - VOLTAGE CODE		
12V AC/DC + 001	24V AC/DC + 002	100-240V AC + 004



 Valvola a sfera 2 vie in tre pezzi, passaggio totale [Valpres artt. 710060 F/F VAP PN15 - 710061 SW VAP PN15 - 710062 BW VAP PN15] per vapore, acciaio inox AISI 316.

 2 way, three piece ball valve, full bore [Valpres artt. 710060 F/F VAP PN15 - 710061 SW VAP PN15 - 710062 BW VAP PN15] for steam, stainless steel AISI 316.



Art. 8P001000 F/F VAP Con attuatore pneumatico doppio effetto serie 82.

Art. 8P001100 SW VAP With double acting pneumatic actuator series 82.

Art. 8P001200 BW VAP

MISURA-SIZE	1/4"	3/8"	1/2"	3/4"	1"	1"1/4"	1"1/2"	2"	2"1/2"	3"	4"
PN	15	15	15	15	15	15	15	15	15	15	15
ACT.	DA32	DA32	DA32	DA52	DA52	DA52	DA63	DA75	DA85	DA85	DA100
KIT	RI3015	RI3015	RI3789	RI3781	RI3030	RI3030	RI3031	RI3034	RI3003	RI3003	RI3004

*Solo F/F - Only F/F.

Art. 8P001600 F/F VAP Con attuatore pneumatico semplice effetto serie 82.

Art. 8P001700 SW VAP With spring return pneumatic actuator series 82.

Art. 8P001800 BW VAP

MISURA-SIZE	1/4"	3/8"	1/2"	3/4"	1"	1"1/4"	1"1/2"	2"	2"1/2"	3"	4"
PN	15	15	15	15	15	15	15	15	15	15	15
ACT.	SR52	SR52	SR52	SR63	SR63	SR63	SR85	SR100	SR115	SR125	SR125
KIT	RI3021	RI3021	RI3790	RI3783	RI3033	RI3033	RI3034	RI3034	RI3010	RI3010	RI3005

*Solo F/F - Only F/F.



Valvola a sfera 2 vie in tre pezzi, passaggio totale [Valpres art. 713000 F/F - 714000 SW - 715000 BW] acciaio al carbonio LCB con sfera e asta in inox AISI 304.

2 way, three piece ball valve, full bore [Valpres art. 713000 F/F - 714000 SW - 715000 BW] carbon steel LCB with ball and stem in stainless steel AISI 304.



Art. 8P001900 F/F Con attuatore pneumatico doppio effetto serie 82.
Art. 8P002000 SW With double acting pneumatic actuator series 82.
Art. 8P002100 BW

MISURA-SIZE	1/4**	3/8"	1/2"	3/4"	1"	1"1/4	1"1/2	2"	2"1/2	3"	4"
PN	64	64	64	40	40	25	25	25	16	16	16
ACT.	DA32	DA32	DA32	DA52	DA52	DA52	DA63	DA75	DA85	DA85	DA100
KIT	RI3015	RI3015	RI3789	RI3781	RI3030	RI3030	RI3031	RI3034	RI3003	RI3003	RI3004

*Solo F/F - Only F/F.

Art. 8P002500 F/F Con attuatore pneumatico semplice effetto serie 82.
Art. 8P002600 SW With spring return pneumatic actuator series 82.
Art. 8P002700 BW

MISURA-SIZE	1/4**	3/8"	1/2"	3/4"	1"	1"1/4	1"1/2	2"	2"1/2	3"	4"
PN	64	64	64	40	40	25	25	25	16	16	16
ACT.	SR52	SR52	SR52	SR63	SR63	SR63	SR85	SR100	SR115	SR125	SR125
KIT	RI3021	RI3021	RI3790	RI3783	RI3033	RI3033	RI3034	RI3034	RI3010	RI3010	RI3005

*Solo F/F - Only F/F.



Art. 8E004* F/F** Con attuatore elettrico serie 85.
Art. 8E032* SW** With electric actuator series 85.
Art. 8E033* BW**

MISURA-SIZE	1/4**	3/8"	1/2"	3/4"	1"	1"1/4	1"1/2	2"	2"1/2	3"	4"
PN	64	64	64	40	40	25	25	25	16	16	16
ACT.	VB015	VB015	VB015	VB015	VB030	VB030	VB060	VB060	VB110	VB110	VB190
KIT	RI3021	RI3021	RI3790	RI3781	RI3030	RI3030	RI3031	RI3031	RI3003	RI3003	RI3004

12 V

24 V

100 - 240 V

*Solo F/F - Only F/F.



Art. 8M004* F/F** Con attuatore elettrico serie 86.
Art. 8M032* SW** With electric actuator series 86.
Art. 8M033* BW**

MISURA-SIZE	1/4"	3/8"	1/2"	3/4"	1"	1"1/4	1"1/2	2"	2"1/2	3"	4"
PN	-	-	-	-	40	25	25	25	16	16	16
ACT.	-	-	-	-	VB030M	VB030M	VB060M	VB060M	VB110M	VB110M	VB190M
KIT	-	-	-	-	RI3030	RI3030	RI3031	RI3031	RI3003	RI3003	RI3004

12 V

24 V

100 - 240 V

CODICE TENSIONE - VOLTAGE CODE

12V AC/DC
+ 001

24V AC/DC
+ 002

100-240V AC
+ 004



 Valvola a sfera 2 vie in tre pezzi, passaggio totale [Valpres artt. 710063 F/F VAP PN15 - 710064 SW VAP PN15 - 710065 BW VAP PN15] per vapore, acciaio al carbonio LCB con sfera e asta in inox AISI 304.

 2 way, three piece ball valve, full bore [Valpres artt. 710063 F/F VAP PN15 - 710064 SW VAP PN15 - 710065 BW VAP PN15] for steam, carbon steel LCB, with ball and stem in stainless steel AISI 304.



Art. 8P002200 F/F VAP Con attuatore pneumatico doppio effetto serie 82.

Art. 8P002300 SW VAP With double acting pneumatic actuator series 82.

Art. 8P002400 BW VAP

MISURA-SIZE	1/4**	3/8"	1/2"	3/4"	1"	1"1/4	1"1/2	2"	2"1/2	3"	4"
PN	15	15	15	15	15	15	15	15	15	15	15
ACT.	DA32	DA32	DA32	DA52	DA52	DA52	DA63	DA75	DA85	DA85	DA100
KIT	RI3015	RI3015	RI3789	RI3781	RI3030	RI3030	RI3031	RI3034	RI3003	RI3003	RI3004

*Solo F/F - Only F/F.

Art. 8P002800 F/F VAP Con attuatore pneumatico semplice effetto serie 82.



Art. 8P002900 SW VAP With spring return pneumatic actuator series 82.

Art. 8P003000 BW VAP

MISURA-SIZE	1/4**	3/8"	1/2"	3/4"	1"	1"1/4	1"1/2	2"	2"1/2	3"	4"
PN	15	15	15	15	15	15	15	15	15	15	15
ACT.	SR52	SR52	SR52	SR63	SR63	SR63	SR85	SR100	SR115	SR125	SR125
KIT	RI3021	RI3021	RI3790	RI3783	RI3033	RI3033	RI3034	RI3034	RI3010	RI3010	RI3005

*Solo F/F - Only F/F.



 Valvola a sfera 2 vie lucida, in acciaio inox AISI 316 con guarnizioni in P.T.F.E. vergine, filettata F/F.
 2 way stainless steel valve AISI 316, polished, seals in P.T.F.E., threaded F/F.



Art. 8P026300 Con attuatore pneumatico doppio effetto serie 82.
With double acting pneumatic actuator series 82.

MISURA-SIZE	1/4"	3/8"	1/2"	3/4"	1"	1"1/4	1"1/2	2"	2"1/2	3"	4"
PN	64	64	64	64	40	40	40	25	25	25	25
ACT.	DA52	DA52	DA52	DA52	DA63	DA63	DA63	DA63	DA85	DA85	DA85
KIT	-	-	-	-	-	-	-	-	-	-	-

Art. 8P026400 Con attuatore pneumatico semplice effetto serie 82.
With spring return pneumatic actuator series 82.

MISURA-SIZE	1/4"	3/8"	1/2"	3/4"	1"	1"1/4	1"1/2	2"	2"1/2	3"	4"
PN	64	64	64	64	40	40	40	25	25	25	25
ACT.	SR52	SR52	SR52	SR52	SR85	SR85	SR85	SR85	SR100	SR125	SR125
KIT	-	-	-	-	-	-	-	-	-	-	-





Art. 8E148*** Con attuatore elettrico serie 85.
With electric actuator series 85.

MISURA-SIZE	1/4"	3/8"	1/2"	3/4"	1"	1"1/4	1"1/2	2"	2"1/2	3"	4"
PN	64	64	64	64	40	40	40	25	25	25	25
ACT.	VB015	VB015	VB015	VB015	VB030*	VB030*	VB060	VB060	VB110	VB110	VB110
KIT	-	-	-	-	-	-	-	-	-	-	-
12 V											
24 V											
100 - 240 V											

*Versione speciale - Special version.

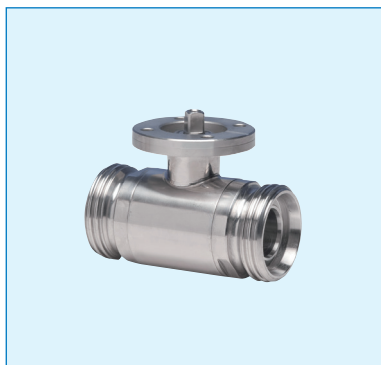
*** CODICE TENSIONE - VOLTAGE CODE		
12V AC/DC + 001	24V AC/DC + 002	100-240V AC + 004



 Valvola a sfera 2 vie ricavata da massello, con guarnizioni in P.T.F.E. vergine, lucida, acciaio inox AISI 316, attacchi DIN 11851 F/F.

 2 way ball valve, from ingot, P.T.F.E. seals, AISI 316, DIN 11851 F/F connections, polished.



Art. 8P022300 Con attuatore pneumatico doppio effetto serie 82.
 With double acting pneumatic actuator series 82.

DN	10	15	20	25	32	40	50	65	80	100
PN	64	64	64	40	40	40	25	25	25	25
ACT.	DA52	DA52	DA52	DA63	DA63	DA63	DA63	DA85	DA85	DA85
KIT	-	-	-	-	-	-	-	-	-	-

Art. 8P022400 Con attuatore pneumatico semplice effetto serie 82.
 With spring return pneumatic actuator series 82.

DN	10	15	20	25	32	40	50	65	80	100
PN	64	64	64	40	40	40	25	25	25	25
ACT.	SR52	SR52	SR52	SR85	SR85	SR85	SR85	SR100	SR125	SR125
KIT	-	-	-	-	-	-	-	-	-	-



Art. 8E124*** Con attuatore elettrico serie 85.
 With electric actuator series 85.

DN	10	15	20	25	32	40	50	65	80	100
PN	64	64	64	40	40	40	25	25	25	25
ACT.	VB015	VB015	VB015	VB030*	VB030*	VB060	VB060	VB110	VB110	VB110
KIT	-	-	-	-	-	-	-	-	-	-
12 V										
24 V										
100 - 240 V										

*Versione speciale - Special version.

*** CODICE TENSIONE - VOLTAGE CODE		
12V AC/DC + 001	24V AC/DC + 002	100-240V AC + 004



 Valvola a sfera 2 vie ricavata da massello, con guarnizioni in P.T.F.E. vergine, lucida, acciaio inox AISI 316, passaggio totale e ridotto, attacchi clamp ISO 2852, DIN 32676 TAB.4 REIHE C per tubo BS/OD (ASTM A270).

 2 way ball valve, from ingot, AISI 316 clamp connections ISO 2852, DIN TABLE 4 REIHE C for tube BS/OD (ASTM A270) P.T.F.E. seals, polished, full bore or reduced bore.



Art. 8P025300 Con attuatore pneumatico doppio effetto serie 82.
With double acting pneumatic actuator series 82.

DN	10	15	20	25	32	40	50	65	80	100
PN	64	64	64	40	40	40	25	25	25	25
CLAMP	1/2"	3/4"	1"	1"	1"1/2	1"1/2	2"	2"1/2	3"	4"
ACT.	DA52	DA52	DA52	DA63	DA63	DA63	DA63	DA85	DA85	DA85

Art. 8P025400 Con attuatore pneumatico semplice effetto serie 82.
With spring return pneumatic actuator series 82.

DN	10	15	20	25	32	40	50	65	80	100
PN	64	64	64	40	40	40	25	25	25	25
CLAMP	1/2"	3/4"	1"	1"	1"1/2	1"1/2	2"	2"1/2	3"	4"
ACT.	SR52	SR52	SR52	SR85	SR85	SR85	SR85	SR100	SR125	SR125



Art. 8E143*** Con attuatore elettrico serie 85.
With electric actuator series 85.

DN	10	15	20	25	32	40	50	65	80	100
PN	64	64	64	40	40	40	25	25	25	25
CLAMP	1/2"	3/4"	1"	1"	1"1/2	1"1/2	2"	2"1/2	3"	4"
ACT.	VB015	VB015	VB015	VB030*	VB030*	VB060	VB060	VB110	VB110	VB110
12 V										
24 V										
100 - 240 V										

*Versione speciale - Special version.

***	CODICE TENSIONE - VOLTAGE CODE	
12V AC/DC + 001	24V AC/DC + 002	100-240V AC + 004



 Valvola a sfera 2 vie in acciaio inox AISI 316L, filettata F/F Fire Safe BS6755, dispositivo antistatico, per alta pressione, idonee per olio (idraulico ecc...), emulsione, gas metano. Per applicazioni particolari consultare l'ufficio commerciale.

 2 way ball valve, AISI 316L, F/F threaded, Fire Safe BS6755, Antistatic Device, high pressure, for hydraulic oil, emulsion, gas. For particular applications refer to sales department.

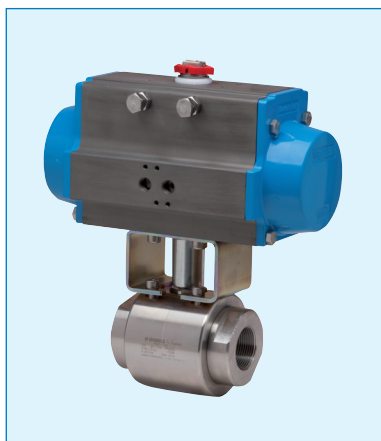

Art. 8P022700 Con attuatore pneumatico doppio effetto serie 82.
 With double acting pneumatic actuator series 82.

MISURA-SIZE	3/8"	1/2"	3/4"	1"	1"1/4	1"1/2	2"
PN	500	500	400	350	350	350	350
ACT.	DA52	DA63	DA75	DA75	DA100	DA100	DA115
KIT	RI4220	RI4221	RI4222	RI4222	RI4482	RI4223	RI4224

Art. 8P022800 Con attuatore pneumatico semplice effetto serie 82.
 With spring return pneumatic actuator series 82.

MISURA-SIZE	3/8"	1/2"	3/4"	1"	1"1/4	1"1/2	2"
PN	500	500	400	350	350	350	350
ACT.	SR75	SR75	SR100	SR100	SR115	SR115	SR140
KIT	RI4225	RI4225	RI4222	RI4222	RI4226	RI4227	RI4228



Art. 8E126*** Con attuatore elettrico serie 85.
 With electric actuator series 85.

MISURA-SIZE	3/8"	1/2"	3/4"	1"	1"1/4	1"1/2	2"
PN	500	500	400	350	350	350	350
ACT.	VB030	VB030	VB030*	VB060	VB110	VB110	VB270
KIT	RI4220	RI4220	RI4229	RI4229	RI4482	RI4223	RI4224
12 V							
24 V							
100 - 240 V							

*Versione speciale - Special version.



Art. 8M126*** Con attuatore elettrico serie 86.
 With electric actuator series 86.

MISURA-SIZE	3/8"	1/2"	3/4"	1"	1"1/4	1"1/2	2"
PN	500	500	400	350	350	350	350
ACT.	VB030M	VB030M	VB030M*	VB060M	VB110M	VB110M	VB270M
KIT	RI4220	RI4220	RI4229	RI4229	RI4482	RI4223	RI4224
12 V							
24 V							
100 - 240 V							

*Versione speciale - special version.

*** CODICE TENSIONE - VOLTAGE CODE		
12V AC/DC + 001	24V AC/DC + 002	100-240V AC + 004



 Valvola a sfera 2 vie in 9SMnPb36, filettata F/F per alta pressione, idonee per olio (idraulico ecc...), emulsione, gas metano. Per applicazioni particolari consultare l'ufficio commerciale.

 2 way ball valve, 9SMnPb36 F/F threaded, high pressure, for hydraulic oil, emulsion, gas. For particular applications refer to sales department.



Art. 8P013700 Con attuatore pneumatico doppio effetto serie 82.
With double acting pneumatic actuator series 82.

MISURA-SIZE	3/8"	1/2"	3/4"	1"	1"1/4"	1"1/2"	2"
PN	500	500	400	350	350	350	350
ACT.	DA52	DA63	DA75	DA75	DA100	DA100	DA115
KIT	RI3740	RI3741	RI3742	RI3742	RI4027	RI4027	RI4019

Art. 8P013800 Con attuatore pneumatico semplice effetto serie 82.
With spring return pneumatic actuator series 82.

MISURA-SIZE	3/8"	1/2"	3/4"	1"	1"1/4"	1"1/2"	2"
PN	500	500	400	350	350	350	350
ACT.	SR75	SR75	SR100	SR100	SR115	SR115	SR140
KIT	RI3745	RI3745	RI3742	RI3742	RI4028	RI4028	RI3746



Art. 8E050*** Con attuatore elettrico serie 85.
With electric actuator series 85.

MISURA-SIZE	3/8"	1/2"	3/4"	1"	1"1/4"	1"1/2"	2"
PN	500	500	400	350	350	350	350
ACT.	VB030	VB030	VB030	VB060	VB110	VB110	VB270
KIT	RI3740	RI3740	RI4037	RI4038	RI4027	RI4027	RI4019
12 V							
24 V							
100 - 240 V							



Art. 8M050*** Con attuatore elettrico serie 86.
With electric actuator series 86.

MISURA-SIZE	3/8"	1/2"	3/4"	1"	1"1/4"	1"1/2"	2"
PN	500	500	400	350	350	350	350
ACT.	VB030M	VB030M	VB030M	VB060M	VB110M	VB110M	VB270M
KIT	RI3740	RI3740	RI4037	RI4038	RI4027	RI4027	RI4019
12 V							
24 V							
100 - 240 V							

*** CODICE TENSIONE - VOLTAGE CODE		
12V AC/DC + 001	24V AC/DC + 002	100-240V AC + 004



 Valvola a sfera 2 vie in acciaio inox AISI 316L, filettata F/F per alta pressione, idonee per olio (idraulico ecc...), emulsione, gas metano. Per applicazioni particolari consultare l'ufficio commerciale.

 2 way ball valve, AISI 316L, F/F threaded high pressure, for hydraulic oil, emulsion, gas. For particular applications refer to sales department.

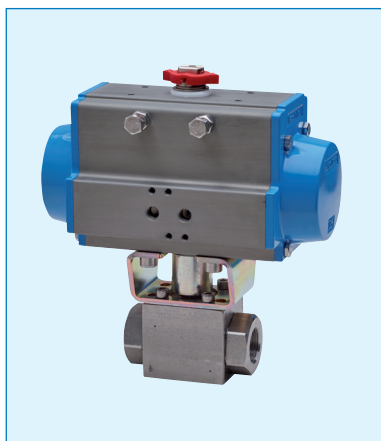

Art. 8P022900 Con attuatore pneumatico doppio effetto serie 82.
 With double acting pneumatic actuator series 82.

MISURA-SIZE	3/8"	1/2"	3/4"	1"	1"1/4"	1"1/2"	2"
PN	500	500	400	350	350	350	350
ACT.	DA52	DA63	DA75	DA75	DA100	DA100	DA115
KIT	RI3740	RI3741	RI3742	RI3742	RI4027	RI4027	RI4019

Art. 8P023000 Con attuatore pneumatico semplice effetto serie 82.
 With spring return pneumatic actuator series 82.

MISURA-SIZE	3/8"	1/2"	3/4"	1"	1"1/4"	1"1/2"	2"
PN	500	500	400	350	350	350	350
ACT.	SR75	SR75	SR100	SR100	SR115	SR115	SR140
KIT	RI3745	RI3745	RI3742	RI3742	RI4028	RI4028	RI3746



Art. 8E127*** Con attuatore elettrico serie 85.
 With electric actuator series 85.

MISURA-SIZE	3/8"	1/2"	3/4"	1"	1"1/4"	1"1/2"	2"
PN	500	500	400	350	350	350	350
ACT.	VB030	VB030	VB030	VB060	VB110	VB110	VB270
KIT	RI3740	RI3740	RI4037	RI4038	RI4027	RI4027	RI4019
12 V							
24 V							
100 - 240 V							



Art. 8M127*** Con attuatore elettrico serie 86.
 With electric actuator series 86.

MISURA-SIZE	3/8"	1/2"	3/4"	1"	1"1/4"	1"1/2"	2"
PN	500	500	400	350	350	350	350
ACT.	VB030M	VB030M	VB030M	VB060M	VB110M	VB110M	VB270M
KIT	RI3740	RI3740	RI4037	RI4038	RI4027	RI4027	RI4019
12 V							
24 V							
100 - 240 V							

CODICE TENSIONE - VOLTAGE CODE

12V AC/DC + 001	24V AC/DC + 002	100-240V AC + 004
--------------------	--------------------	----------------------



 Valvola a sfera 2 vie in PVC con attacchi femmina metrici per incollaggio.

 2 way PVC ball valve with metric thread female connections for glueing.



Art. 8P016100 Con attuatore pneumatico doppio effetto serie 82.
With double acting pneumatic actuator series 82.

DN	10	15	20	25	32	40	50	65	80	100
PN	16	16	16	16	16	16	16	10	10	10
ACT.	DA52	DA52	DA52	DA52	DA63	DA63	DA63	DA63	DA75	DA85
KIT	-	-	-	-	-	-	-	-	-	-

Art. 8P016200 Con attuatore pneumatico semplice effetto serie 82.
With spring return pneumatic actuator series 82.

DN	10	15	20	25	32	40	50	65	80	100
PN	16	16	16	16	16	16	16	10	10	10
ACT.	SR52	SR52	SR52	SR52	SR63	SR75	SR75	SR85	SR100	SR115
KIT	-	-	-	-	-	-	-	-	-	-



Art. 8E059*** Con attuatore elettrico serie 85.
With electric actuator series 85.

DN	10	15	20	25	32	40	50	65	80	100
PN	16	16	16	16	16	16	16	10	10	10
ACT.	VB015	VB015	VB015	VB030	VB030*	VB030*	VB030*	VB030*	VB060	VB110
KIT	-	-	-	-	-	-	-	-	-	-
12 V										
24 V										
100 - 240 V										

*Versione speciale - Special version.

***			CODICE TENSIONE - VOLTAGE CODE		
12V AC/DC + 001	24V AC/DC + 002	100-240V AC + 004			